

# ***MTHP SERIES***

## ***HYDRAULIC MOTOR***

### ***HIGH TORQUE - LOW SPEED***

TYPE		MTHP SERIES						
MOTOR SIZE		130	160	200	250	300	400	500
DISPLACEMENT	cm <sup>3</sup>	142	161	201	250	330	411	524
	in <sup>3</sup>	8.6	9.8	12.3	15.2	20.2	25.1	32.0
MAX. SPEED	rpm cont.	725	625	625	500	380	300	240
	rpm int.	825	780	750	600	460	360	285
MAX. TORQUE	Nm cont.	375	470	590	730	950	1080	1220
	lbf.in cont.	3320	4160	5220	6460	8410	9560	10800
	Nm int.	470	560	710	880	1140	1260	1370
	lbf.in int.	4160	4960	6280	7790	10090	11150	12130
MAX. PRESSURE DROP	bar cont.	200	200	200	200	200	180	160
	psi int.	2900	2900	2900	2900	2900	2610	2320
	bar int.	240	240	240	240	240	210	180
MAX. OIL FLOW	lpm cont.	102	100	125	125	125	125	125
	gpm cont.	22.5	22.0	27.5	27.5	27.5	27.5	27.5
	lpm int.	116	125	151	149.4	152.0	148.0	151.0
	gpm int.	25.6	27.6	33.3	33.0	33.5	32.5	33.0
WEIGHT	kg	21.5	22.0	22.5	23.0	24.0	25.0	26.0

Maximum inlet pressure 4350 psi - 300 bar  
High pressure shaft seal drain line not required for most applications.

Maximum pressure drop and speed must not be reached simultaneously.  
Intermittent operation may occur for 10% max. of every minute.

At speeds lower than 10 rpm please consult our Technical Department.

Mineral based hydraulic fluids with anti-wear additives are recommended with a viscosity of 35 mm<sup>2</sup>/s at a temperature of 50 C.

Minimum recommended oil viscosity 13 mm<sup>2</sup>/s at operating temperature.

Recommended oil cleanliness ISO 19/14 with a nominal filtration of 25 micron or better.

Where non-flammable fluids are to be used it is advisable to consult our Technical Department.

Ambient temperature should be between -30°C and +85°C.

Normal operating temperature should be between +30°C and +60°C.

Maximum operating temperature +85°C.

#### SYMBOL

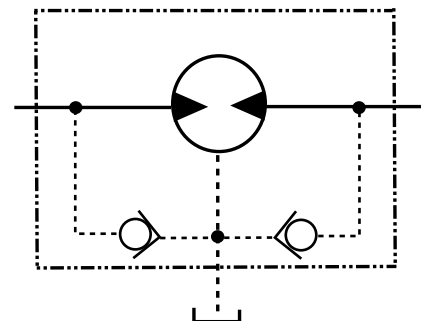

The policy of Adan Limited is one of continual development and the right is reserved to alter specifications without notice



### **ADAN LIMITED**

RIVERSIDE IND. ESTATE · BOSTON · LINCOLNSHIRE · ENGLAND · PE21 7TN

Tel: +44 (01205) 311500

email: sales@adanltd.co.uk

website: www.adanltd.co.uk





# SHAFT VARIATIONS

# MTHP SERIES

**Standard 32mm Shaft - P**  
Max. Torque 770 Nm (6815 lbf-in)

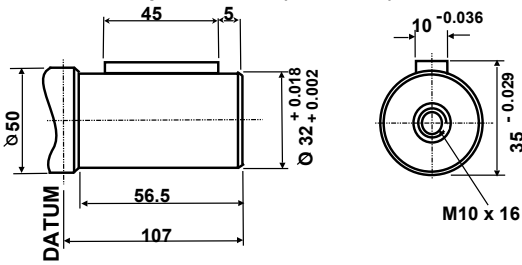

**Splined Shaft - S**  
Max. Torque 950 Nm (8405 lbf-in)

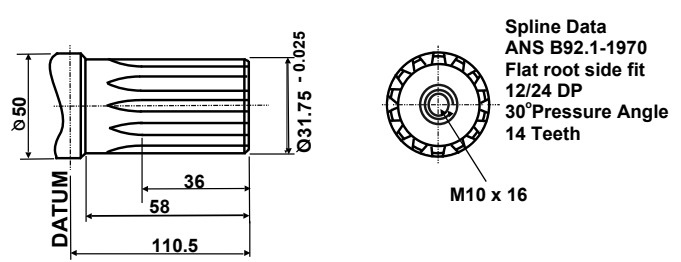

**1 1/4" Dia Shaft - U**  
Max. Torque 770 Nm (6815 lbf-in)

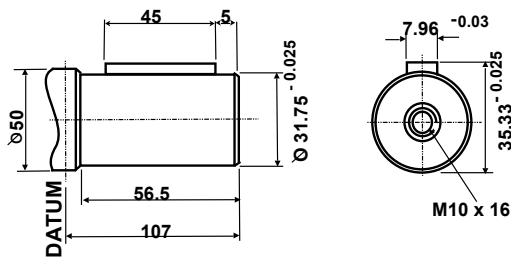

**35mm Tapered Shaft - T**  
Max. Torque 950 Nm (8405 lbf-in)

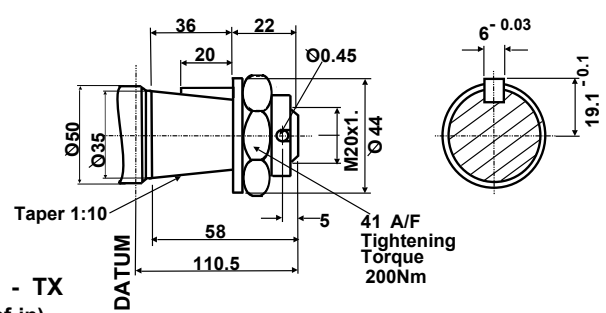

**1 1/4" Dia Tapered Shaft - TX**  
Max. Torque 950 Nm (8405 lbf-in)

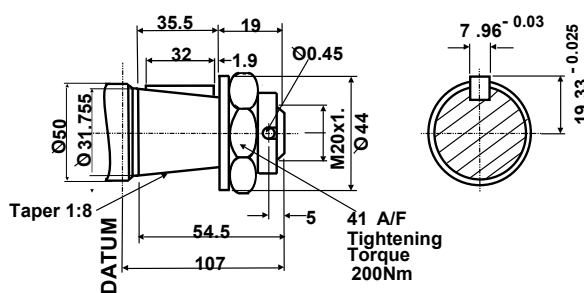

## GENERAL DATA

## MTHP SERIES

### SHAFT ROTATION

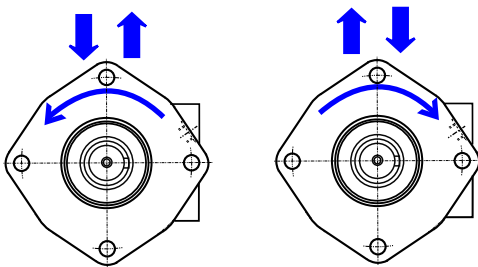

### SHAFT LOADING

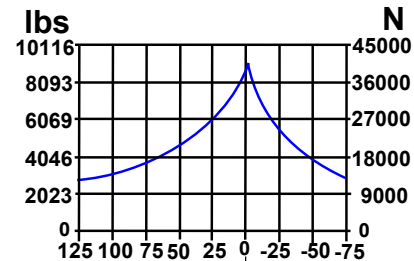

### ORDERING CODE

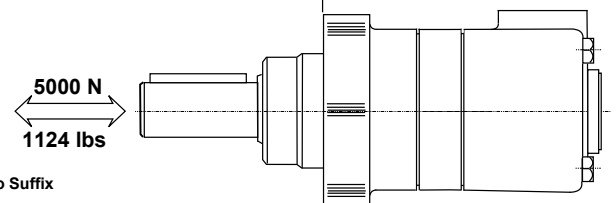
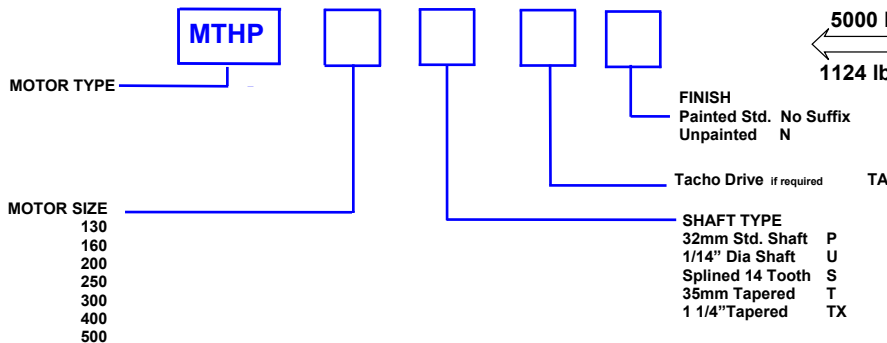

The policy of Adan Limited is one of continual development and the right is reserved to alter specifications without notice



## ADAN LIMITED

RIVERSIDE IND. ESTATE · BOSTON · LINCOLNSHIRE · ENGLAND · PE21 7TN

Tel: +44 (01205) 311500

email: sales@adanltd.co.uk

website: www.adanltd.co.uk



# PERFORMANCE GRAPHS 130 & 160 cc \_\_\_\_\_ MTHP SERIES

Solid blue lines represent continuous operation. Dotted red lines represent intermittent operation permissible for 10% of every minute.

Maximum pressure drop and maximum speed must not occur simultaneously.

## MTHP 130

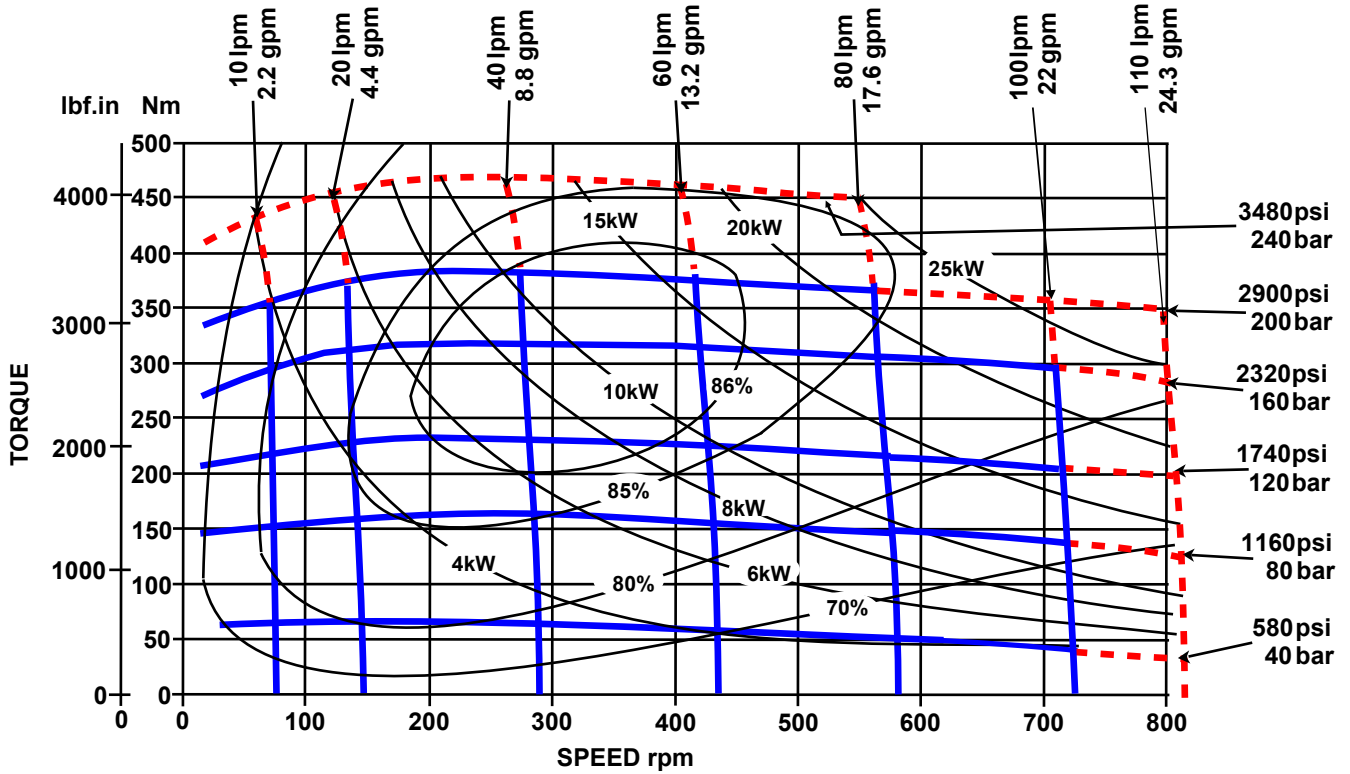

## MTHP 160

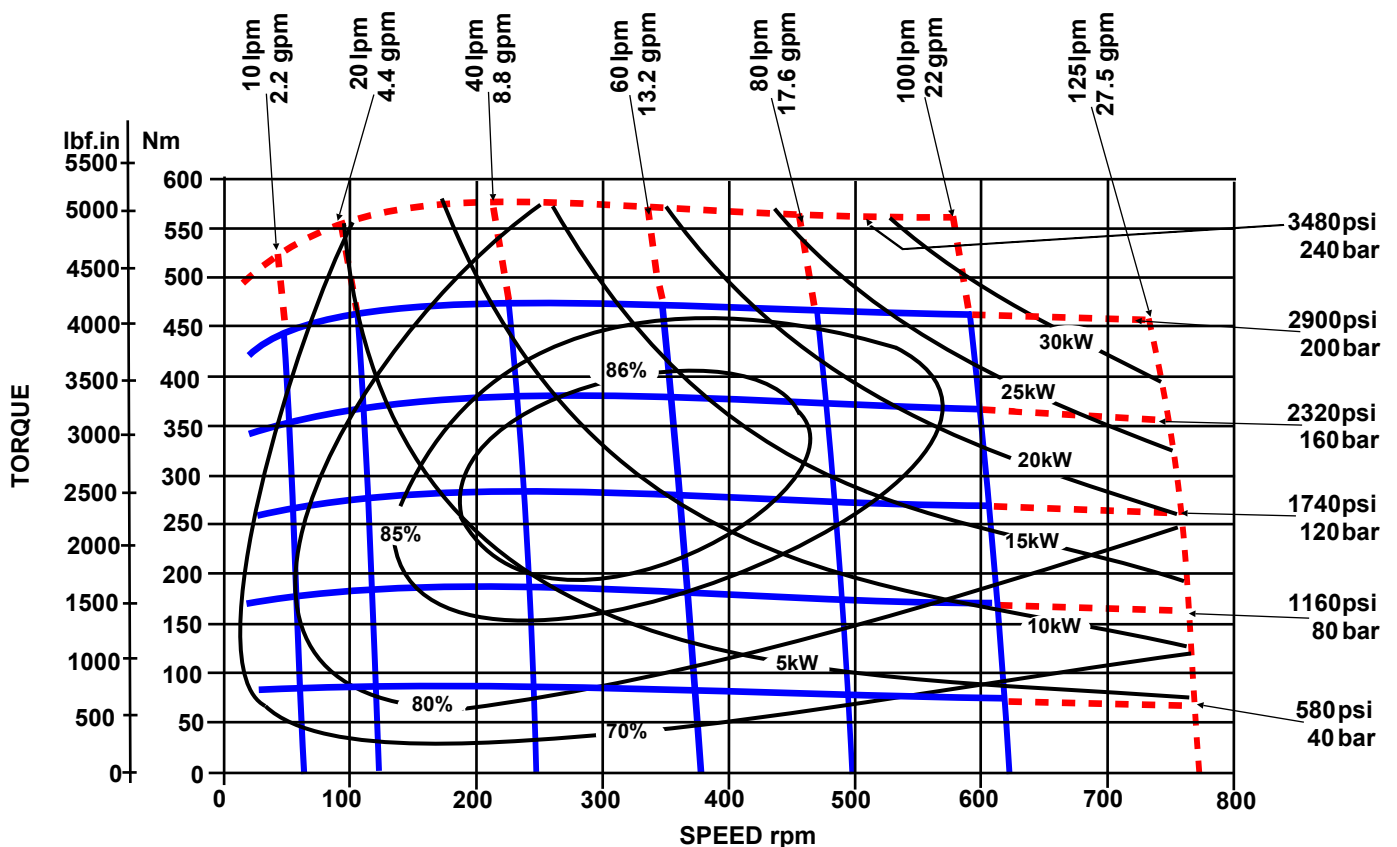

# PERFORMANCE GRAPHS 200 & 250 cc

# MTHP SERIES

Solid blue lines represent continuous operation. Dotted red lines represent intermittent operation permissible for 10% of every minute. Maximum pressure drop and maximum speed must not occur simultaneously.

### MTHP 200

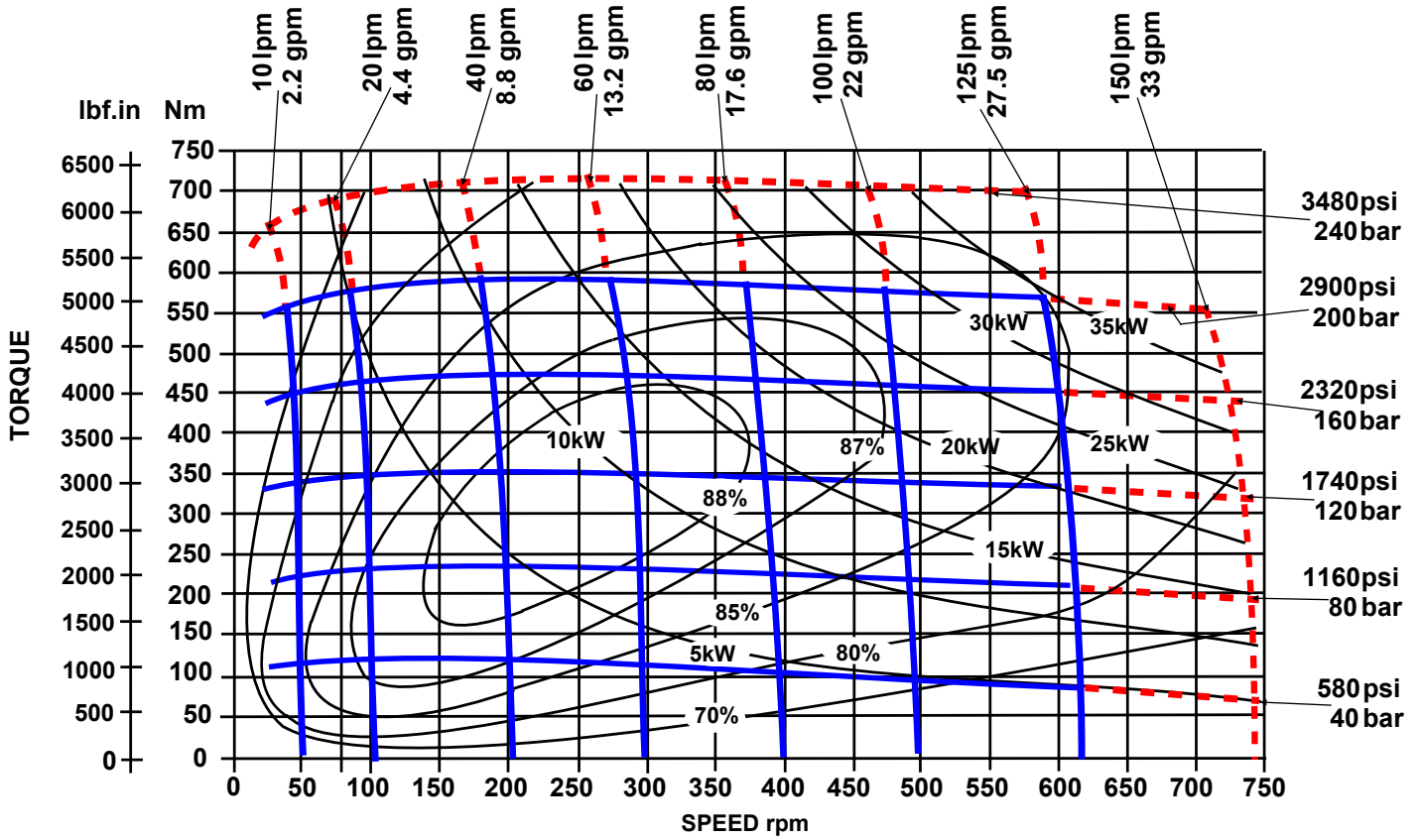

### MTHP 250

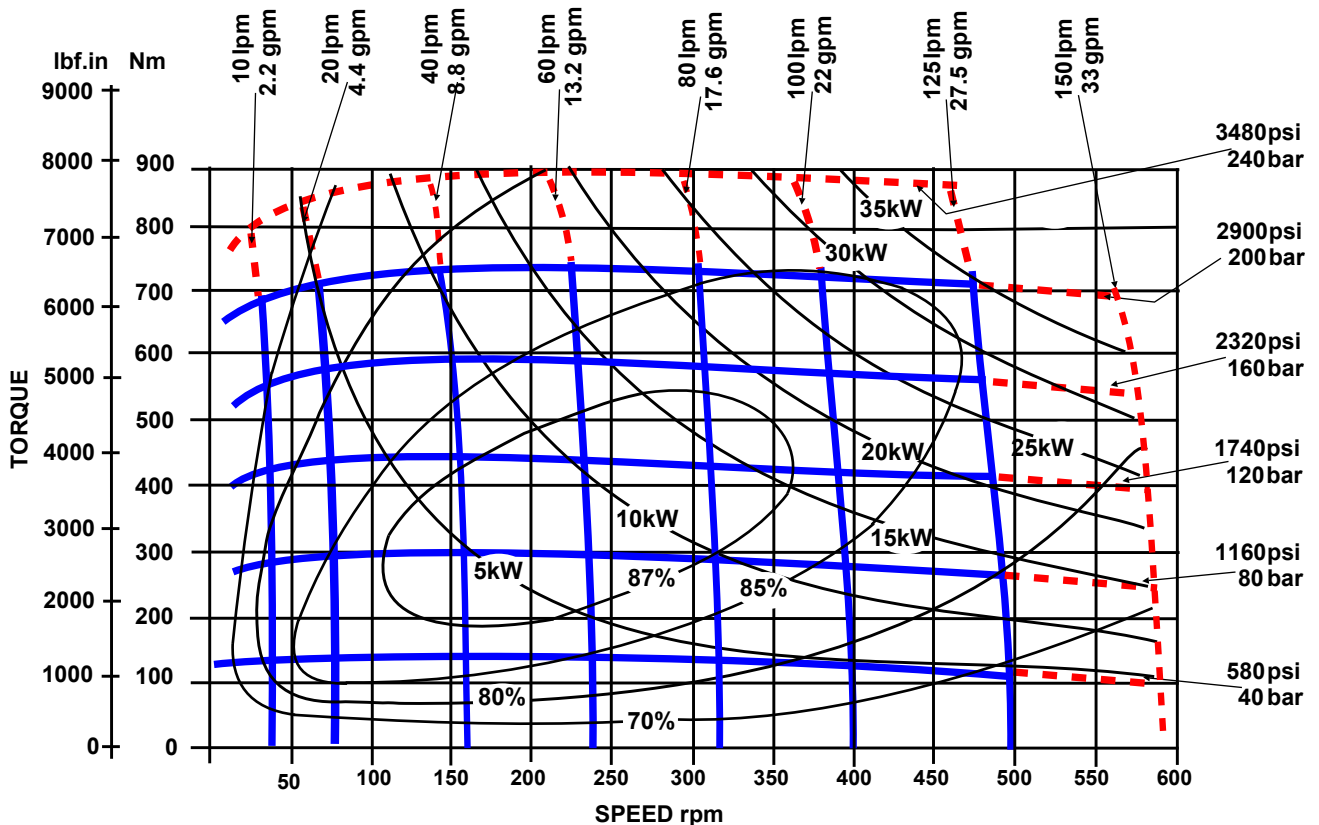

# PERFORMANCE GRAPHS 300 & 400 cc MTHP SERIES

Solid blue lines represent continuous operation. Dotted red lines represent intermittent operation permissible for 10% of every minute.

Maximum pressure drop and maximum speed must not occur simultaneously.

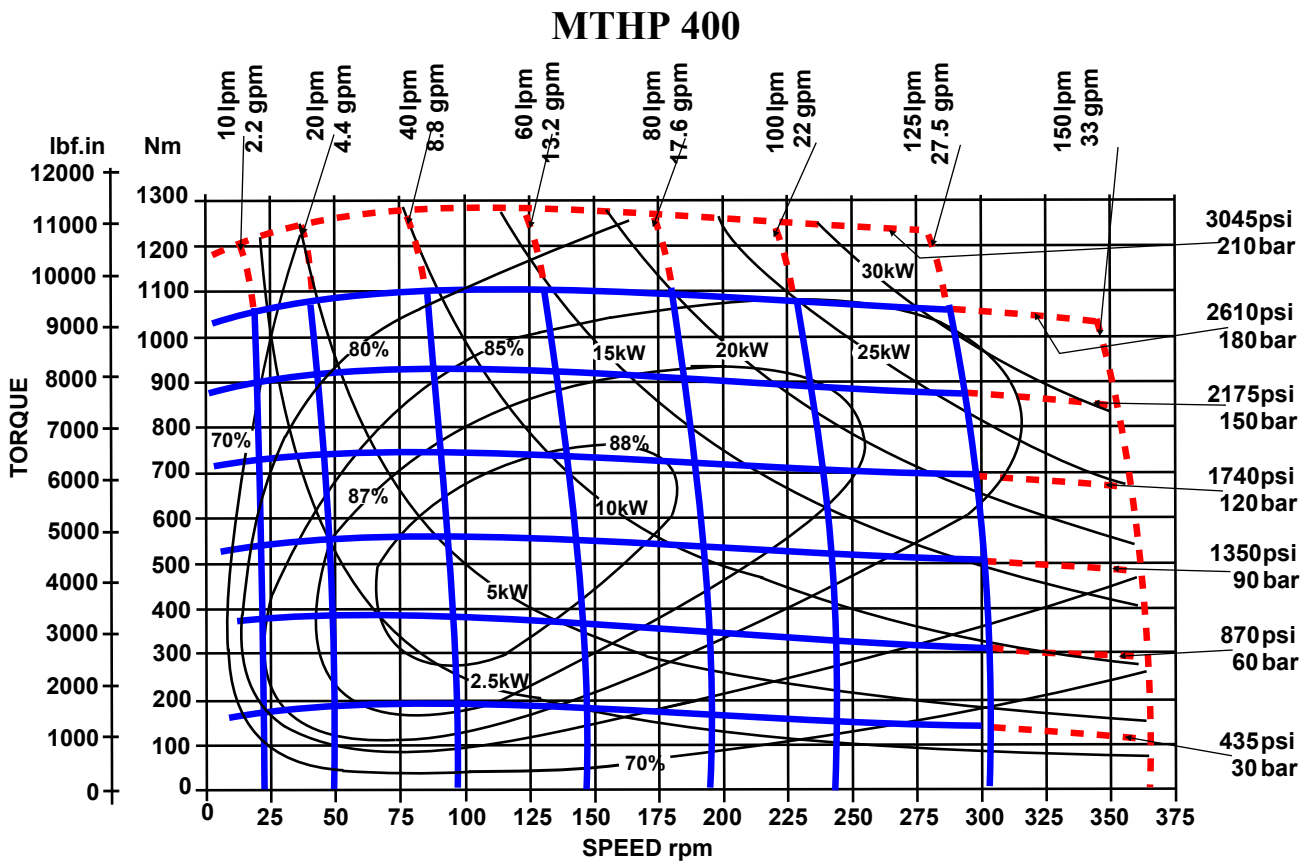
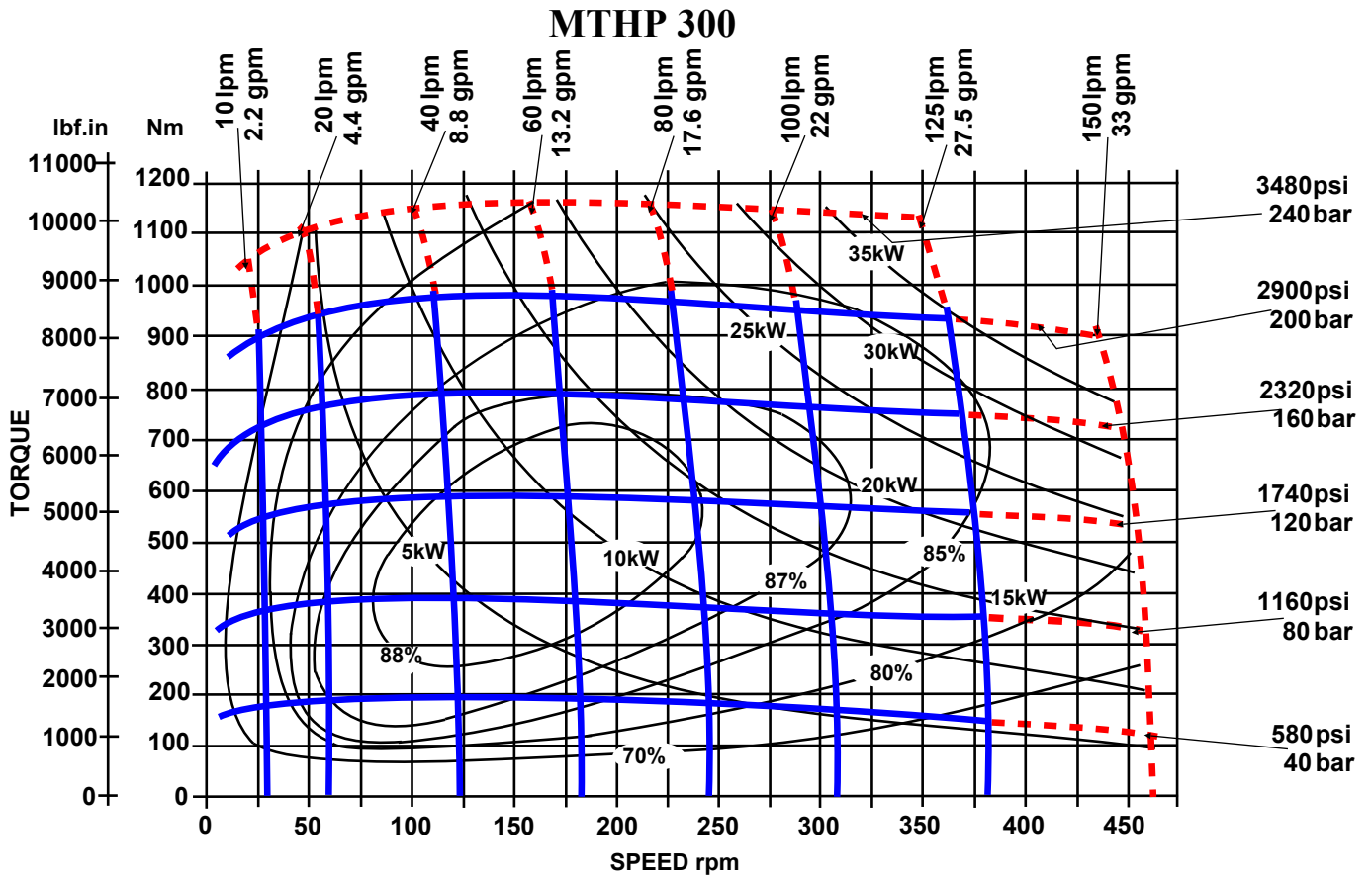



# PERFORMANCE GRAPHS 500 cc MTHP SERIES

Solid blue lines represent continuous operation. Dotted red lines represent intermittent operation permissible for 10% of every minute.

Maximum pressure drop and maximum speed must not occur simultaneously.

## MTHP 500

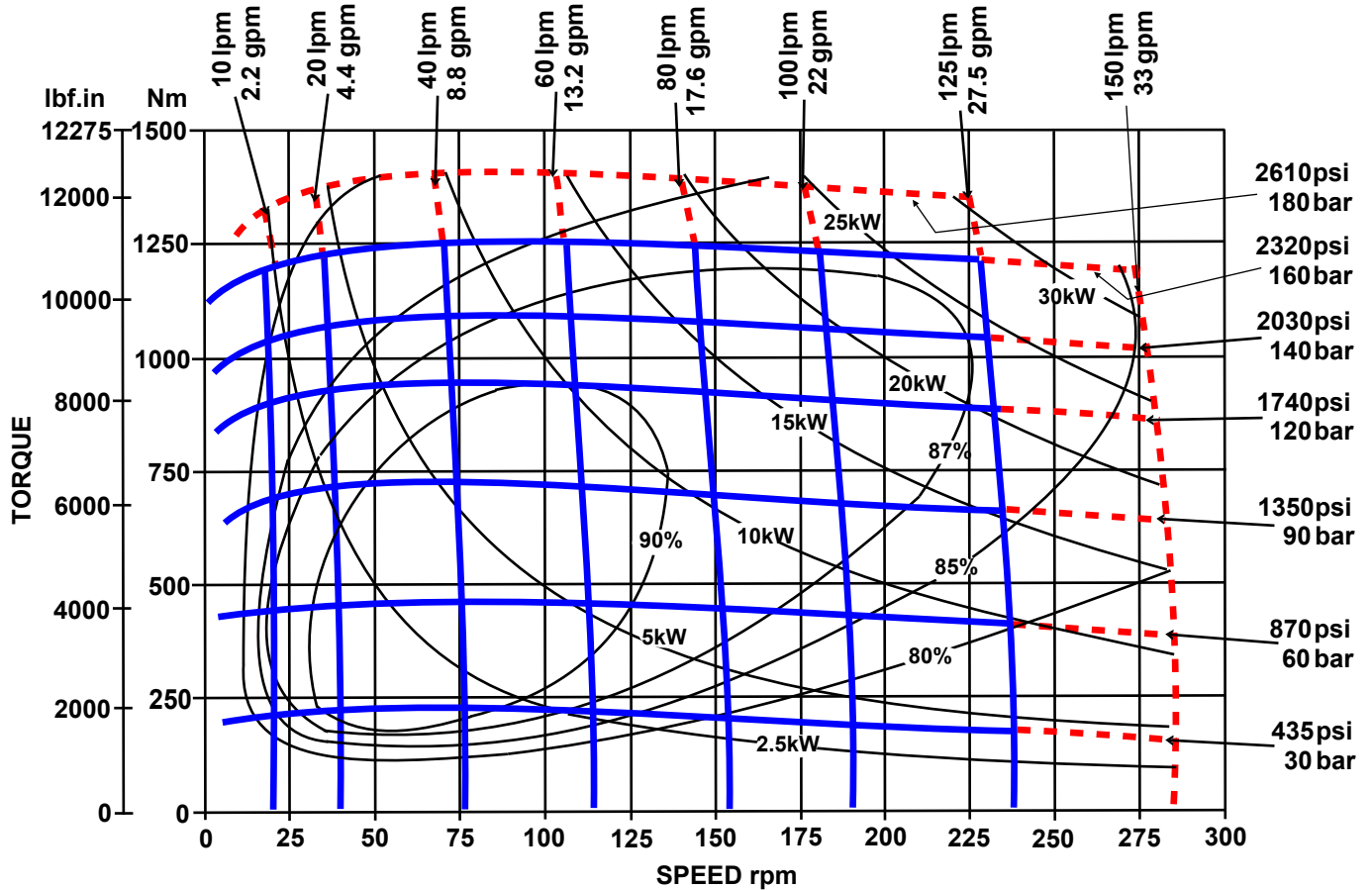

The policy of Adan Limited is one of continual development and the right is reserved to alter specifications without notice.



### ADAN LIMITED

RIVERSIDE IND. ESTATE BOSTON LINCOLNSHIRE ENGLAND

Tel: +44 (01205) 311500

email: sales@adanltd.co.uk

Fax: +44 (01205) 358013

website: www.adanltd.co.uk

